

Project: _____

Fixture Type: _____

Location: _____

Contact/Phone: _____

6" TC 900 LUMEN LED DOWNLIGHT NEW CONSTRUCTION

TC22LED (G4 09LM) RECESSED HOUSING



LENSED TRIMS

PRODUCT DESCRIPTION

Dedicated LED new construction housing with integral light engine • Shallow housing allows for fit in 2 x 6 construction • TC housing design for use in non-insulated areas • If installed where insulation is present, the insulation must be pulled back 3" from all sides of the TC housing LED housing is designed to provide 50,000 hours of life and is compatible with many standard Juno trims • 5 year limited warranty on LED components.

ENVIRONMENTALLY FRIENDLY, ENERGY EFFICIENT

- No harmful ultraviolet or infrared wavelengths
- No lead or mercury
- Comparable light output to 26W compact fluorescent while consuming only 18W*

PRODUCT SPECIFICATIONS

LED Light Engine LED array integrated to one piece high purity aluminum, thermally conductive housing provides uninterrupted heat transfer to ensure long life of the LED • Replaceable light engine mounts directly to housing and incorporates the latest generation, high lumen output LED array • LEDs are binned within a 3-Step MacAdam Ellipse exceeding ENERGY STAR® requirements yielding superior fixture to fixture color uniformity • 2700K, 3000K, 3500K or 4000K color temperatures available • 90 CRI minimum.

Optical System Computer-optimized reflector design with high reflectance white finish coupled with a high transmission diffusing lens conceals the LEDs and produces uniform aperture luminance • Wide flood (>70°) distribution shipped as standard with optional optic accessories available and sold separately.

Aesthetic Trim Selections Compatible with wide selection of existing Juno trims • Shadow free, knife edge design blends seamlessly into ceiling.

LED Driver Universal voltage drivers that accommodate input voltage from 120-277 volts AC at 50/60Hz are available and dimmable with the use of most 0-10V dimmers • Power factor > 0.9 at 120V input • Optional Lutron Hi-Lume® A-Series driver accommodates 120-277 volts AC at 50/60Hz • Mounted between the j-box and housing for easy access and cool operation • For a list of compatible dimmers, see [JUNOTCLEDDIM](#).

Emergency Battery Option Battery factory assembled to housing with remote mounted test switch included • Drives LED array for 90 minutes to meet Life Safety Code (NFPA-LSC), National Electrical Code (NEC) and UL requirements • Provides 50% light output in emergency mode.

Life Rated for 50,000 hours at 70% lumen maintenance.

Labels UL listed for U.S. and Canada through-branch wiring, damp locations • Union made • UL and cUL listed • Trim are wet location approved for covered ceiling applications.

Testing All reports are based on published industry procedures; field performance may differ from laboratory performance.

Specifications subject to change without notice.

HOUSING FEATURES

Housing Designed for use in TC applications (non-insulated) • Aluminum housing • Housing is vertically adjustable to accommodate up to a 2" ceiling thickness.

Junction Box Pre-wired junction box provided with (5) 1/2" and (1) 3/4" knockouts and ground wire, UL listed and cUL listed for through-branch wiring, maximum 8 No. 12 AWG 90° C branch circuit conductors (4 in, 4 out) • Junction box provided with removable access plates • Knockouts equipped with pryout slots.

Mounting Frame 16-gauge galvanized steel mounting ring equipped with vertically adjustable mounting brackets that accept 1/2" conduit or "C" channels (HB26 or HB50), linear flat bars (LB27) or Patented (US Patent D552,969) Real Nail® 3 bar hangers (HB1).

*Nominal input wattage with universal voltage driver under stable operating conditions



DIMENSIONS

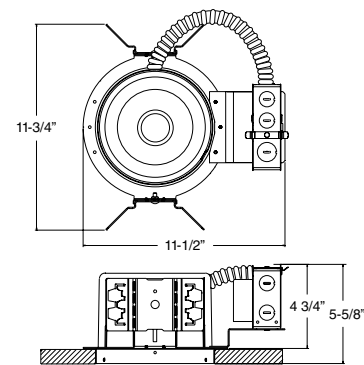

6 7/8" CEILING CUTOUT

ELECTRICAL DATA

STANDARD UNIVERSAL VOLTAGE DRIVER (MVOLT EZ10 and MVOLT EZ1)

	120V	277V
Input Power	16.1W (+/-5%)	16.9W (+/-5%)
Input Current - Max	0.14A	0.06A
Frequency	50/60Hz	50/60Hz
EMI/RFI	FCC Title 47 CFR, Part 15, Class B (residential)	FCC Title 47 CFR, Part 15, Class B (residential)
Minimum starting temp	-20°C (-40°F)	-20°C (-40°F)

UNIVERSAL VOLTAGE DRIVER WITH EMERGENCY OPTION (MVOLT EZ10 BR and MVOLT EZ1 BR)

	120V	277V
Input Power	18.9W (+/-5%)	19.6W (+/-5%)
Input Current - Max	0.16A	0.07A
Frequency	50/60Hz	50/60Hz
EMI/RFI	FCC Title 47 CFR, Part 15, Class A (Commercial)	FCC Title 47 CFR, Part 15, Class A (Commercial)
Minimum starting temp	0°C (32°F)	0°C (32°F)

LUTRON HI-LUME® LED DRIVER (ECOS3)

	120V	277V
Input Power	17.8W (+/-5%)	17.8W (+/-5%)
Input Current - Max	0.15A	0.06A
Frequency	50/60Hz	50/60Hz
EMI/RFI	FCC Title 47 CFR, Part 15, Class A (Commercial)	FCC Title 47 CFR, Part 15, Class A (Commercial)
Minimum starting temp	0°C (32°F)	0°C (32°F)

6" TC 900 LUMEN LED DOWNLIGHT NEW CONSTRUCTION

TC22LED (G4 09LM) RECESSED HOUSING LENSED TRIMS

ORDERING INFORMATION Housing and trim can be ordered together or separate, but will always ship separately.

Example: TC22LED G4 09LM 27K 90CRI MVOLT ZT BR







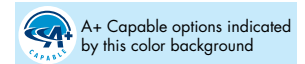

Series	Generation	Lumens	Color Temperature	CRI	Voltage/Driver
TC22LED 6" LED Downlight Non-IC Rated Housing	G4 Generation 4	09LM 900 Nominal Lumens	27K 2700K	90CRI 90+ CRI	MVOLT EZ10 Multi-Volt (120-277), eldoLED 0-10V, 10% dim
			30K 3000K		MVOLT EZ1 Multi-Volt (120-277), eldoLED 0-10V, 1% dim
			35K 3500K		MVOLT ECOS3 Multi-Volt (120-277), Lutron Hi-Lume A series 3 wire fluorescent controls and Lutron Ecosystem
			40K 4000K		

Emergency Battery	Territory
BR Emergency Battery	CP Chicago Plenum

Note: Chicago Plenum (CP) is not available with emergency option (BR)
Note: Lutron driver (MVOLT ECOS3) is not available with emergency battery pack (BR)

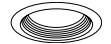

Trim/Description

	20 WH 20 PW	6" Lensed Albalite Trim - White 6" Lensed Albalite Trim - Plastic White
	21 WH 21 PW	6" Lensed Drop Opal Trim - White 6" Lensed Drop Opal Trim - Plastic White
	22 WH	6" Lensed Fresnel Trim - White
	239 WH*	6" Lensed Frosted Lens Trim - White
	242 WH 242 SC 242 ABZ	6" Lensed Frosted Lens with Clear Center Trim - White 6" Lensed Frosted Lens with Clear Center Trim - Satin Chrome 6" Lensed Frosted Lens with Clear Center Trim - Classic Aged Bronze
	243 WH*	6" Decorative Swirled Etched Opal Glass Trim - White
	2330 WWH* 2330 BWH*	6" Lensed Baffle with Regressed Frosted Dome Lens Trim - White, White Trim Ring 6" Lensed Baffle with Regressed Frosted Dome Lens Trim - Black, White Trim Ring
	6101 ABZ* 6101 SC* 6101 WH*	6" Lensed Beveled Frame with Frosted Dome Lens Trim - Classic Aged Bronze 6" Lensed Beveled Frame with Frosted Dome Lens Trim - Satin Chrome 6" Lensed Beveled Frame with Frosted Dome Lens Trim - White

Accessories (ordered separately)

Catalog Number	Description
HB1	Two 13 1/2" - 25" Real Nail® 3 bar hangers
HB26	Two 26" C-channel bar hangers
HB50	Two 50" C-channel bar hangers
LB27	Two 27" linear bar hangers
LEDOPTICG3 MFL	Medium Flood Optic (50°)
LEDOPTICG3 NFL	Narrow Flood Optic (37°)
LEDOPTICG3 SP	Spot Optic (10°)

Trim Size: 2330 - 7 3/8" O.D.; 239, 242, 243 - 7 5/8" O.D.; 6101 - 7 3/4" O.D.; 20, 21, 22 - 8" O.D.

Note: In Canada when insulation is present, Type IC fixtures must be used.

UL Listed for use in wet location.

* Do not use reflector shipped with trim for LED housing.

6" TC 900 LUMEN LED DOWNLIGHT NEW CONSTRUCTION

TC22LED (G4 09LM) RECESSED HOUSING
LENSED TRIMS

PHOTOMETRICS

PHOTOMETRIC REPORT

Test Report #: PT10111804R
Catalog No: TC22LED G4 09LM 35K with
239 WH Trim and Standard Wide Flood Optic
Luminaire Spacing Criterion: 1.02
Luminaire LPW: 53

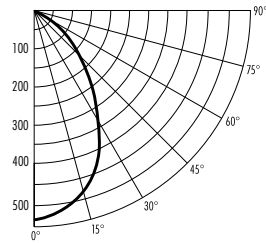

CANDLEPOWER DISTRIBUTION (Candelas)

Degrees	Vertical	0°
0	543	
5	536	
15	493	
25	405	
35	276	
45	161	
55	95	
65	56	
75	32	
85	7	
90	0	
Multiplier:		27K - 0.93
		30K - 0.99
		40K - 1.01

AVERAGE INITIAL FOOTCANDLES

Multiple Units (Square Array, 60'x60' room)
Ceiling 80% Wall 50% Floor 20%

Spacing	RCR1	RCR3	RCR5
4.0'	57	46	38
5.0'	37	29	24
6.0'	25	20	17
7.0'	21	17	14
8.0'	16	13	11
9.0'	12	10	8
10.0'	9	7	6

ZONAL LUMEN SUMMARY

Zone	Lumens	%Lamp	%Fixture
0-30°	374	N/A	43.6
0-40°	546	N/A	63.7
0-60°	758	N/A	88.5
0-90°	857	N/A	100.0

INITIAL FOOTCANDLES (One Unit, 16.1W, 70.8° Beam)

Distance to Illuminated Plane (Feet)	Footcandles Beam Center	Beam Diameter
4	33.9	5.7'
6	15.1	8.5'
8	8.5	11.4'
10	5.4	14.2'

LUMINANCE (Average cd/m²)

Degrees	Average 0° Luminance
45	12472
55	9035
65	7314
75	6674
85	4173

Fixtures tested to IES recommended standard for solid state lighting per LM-79-08. Photometric performance on a single unit represents a baseline of performance for the fixture. Results may vary in the field.